

391352 (E9PCEDRMC0)

Electric freestanding Re-thermalizer with 1 well, 40 litres - 415 V

Optional Accessories

PNC Code	Description
Kicking strips	
206176	Frontal kicking strip, 800mm (not for refr-freezer base)

Recommended Detergents

PNC Code	Description
OS2292	C41 HI-TEMP RAPID DEGREASER, 1 pack of six 1 lt bottles (trigger incl.)
OS2881	S01 STAINLESS STEEL SURFACE POLISHER; 6 BOTTLES X 750ML C/T
OS2882	S02 Degreaser for ovens and SpeedDelight. Specific for cleaning the cooking chambers of GourmeXpress and SpeeDelight. Active up to a maximum of 50°C Complete with spray bottle Pack of 6 750ml bottles
OS2883	S03 ALCOHOL BASE DETERGENT; 6 BOTTLES X 750ML; ADR&IMDG&IATA Limited Quantity
OS2884	S04 GLASSES & HARD SURFACES CLEANERS; 6 BOTTLES X 750ML
OS3257	S05 - MULTIPURPOSE DEGREASER; 6PCS X 750ML; ADR&IMDG Limited Quantity



Technical specifications

Electric

Supply voltage:	415 V/3N ph/50 Hz
Total Watts:	10 kW

Water:

Incoming Cold/hot Water line size:	3/4"
Drain line size:	3/4"

Key Information:

Number of wells:	
Usable well dimensions (width):	300 mm
Usable well dimensions (height):	260 mm
Usable well dimensions (depth):	510 mm
Well capacity:	22 lt MIN; 40 lt MAX
Thermostat Range:	85 °C MIN; 95 °C MAX
External dimensions, Width:	400 mm
External dimensions, Depth:	933 mm
External dimensions, Height:	850 mm
Shipping weight:	68 kg
Shipping height:	1080 mm
Shipping width:	460 mm
Shipping depth:	1020 mm
Shipping volume:	0.51 m ³
Configuration:	Free Standing
Approvals	CE;CB;WRAS
Certification group:	N9RT

Front

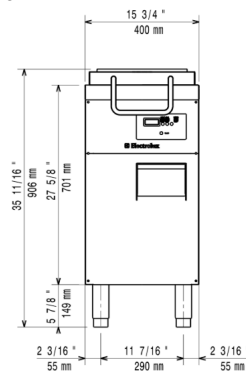

Side

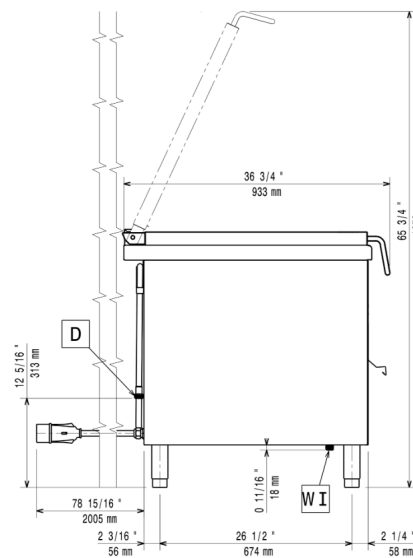

Top

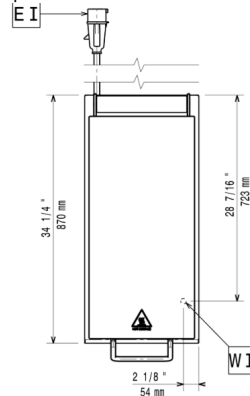

- D = Drain
- EI = Electrical inlet (power)
- EQ = Equipotential screw
- DO = Overflow drain pipe



Find out more:
ISO Certificates
Electrolux Professional Recognitions

The company reserves the right to make modifications to the products without prior notice. All information correct at time of printing.

2026/03/30